

PROTEXOR - HECKKANTENSCHUTZ
 PROTEXOR - REAR PROTECTOR
 Einbauanleitung - Fitting instructions

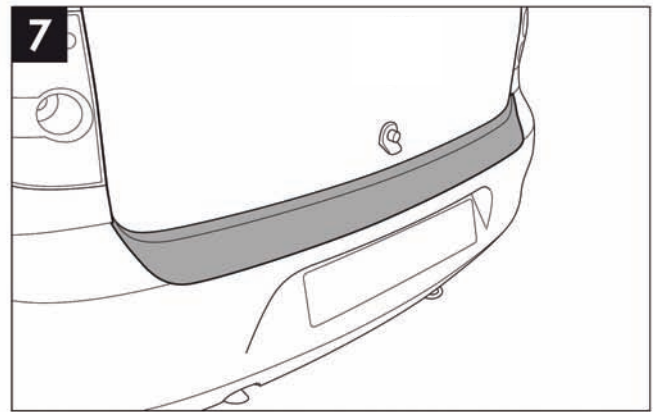

Verwenden Sie nur Wasser mit Seife oder Autoschampoo für die Reinigung Ihres Heckkantenschutz „PROTEXOR“. Spülen Sie mit klarem Wasser ab und trocknen den Rest ab.
 Use only water with a proprietary soap or car shampoo for cleaning your REAR PROTECT OR. Rinse off with clean water and dry as per remainder of the bodywork.

PROTEXOR - HECKKANTENSCHUTZ
PROTEXOR - REAR PROTECTOR
Einbauanleitung - Fitting instructions

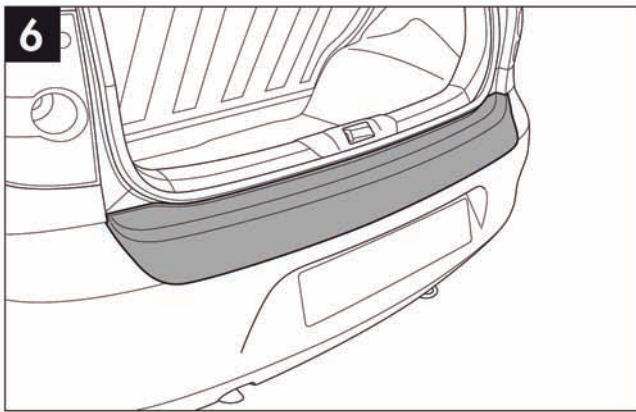
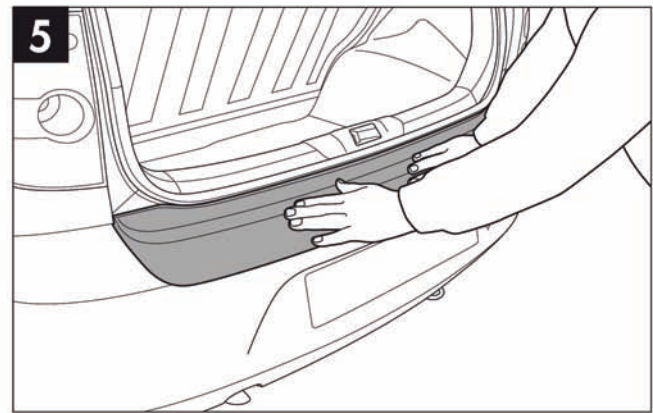
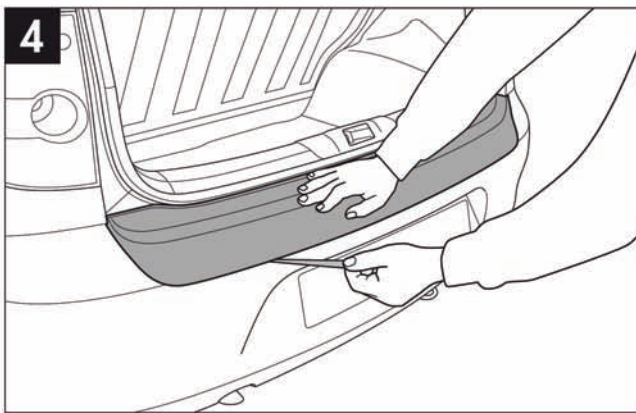
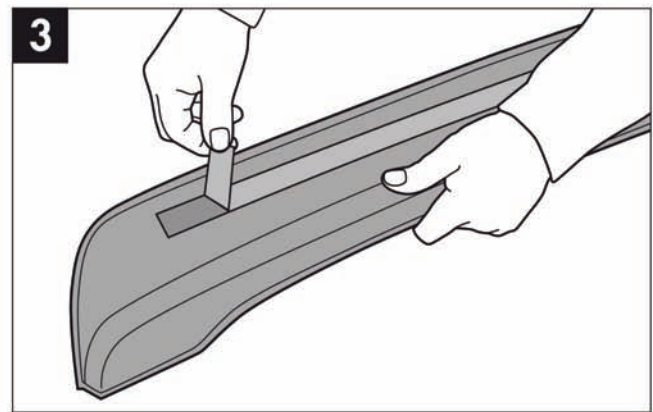
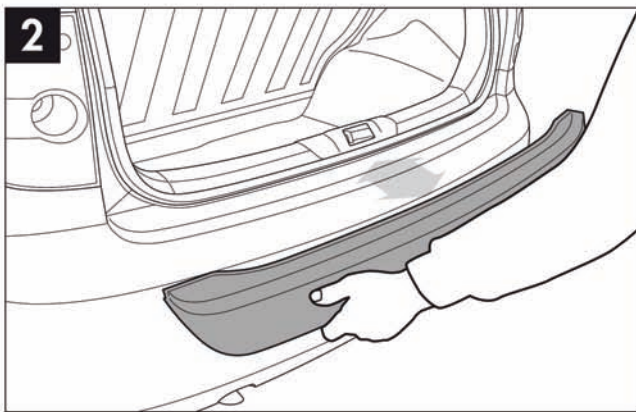
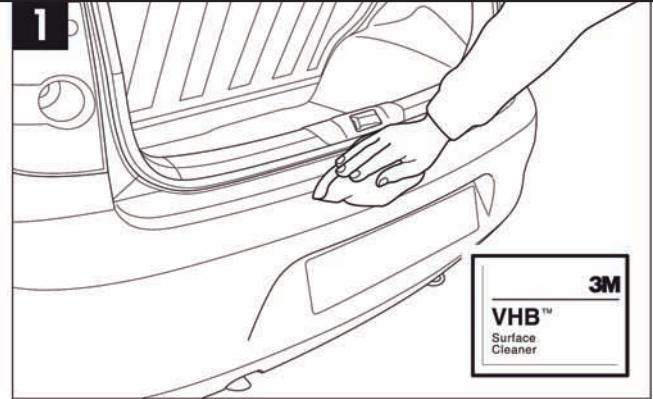
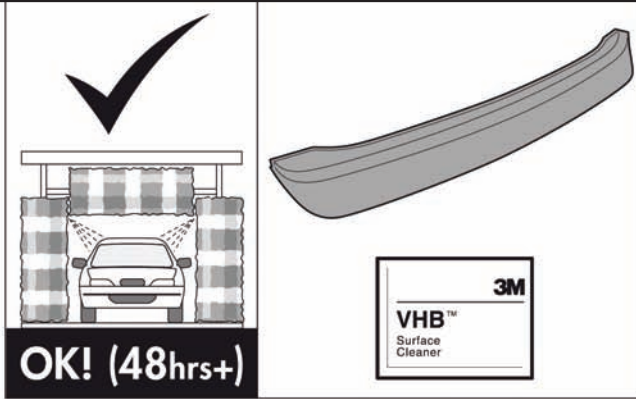
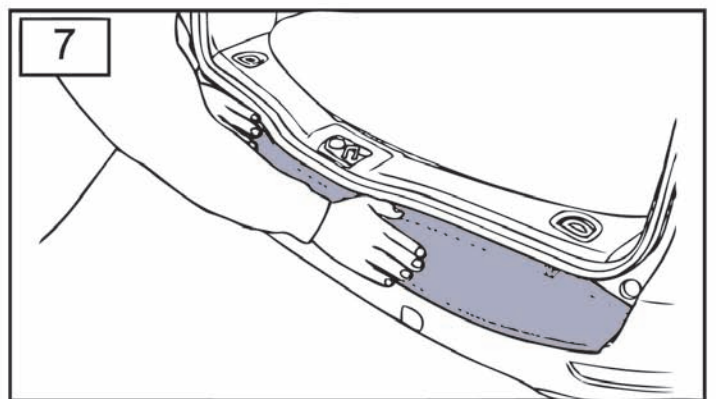
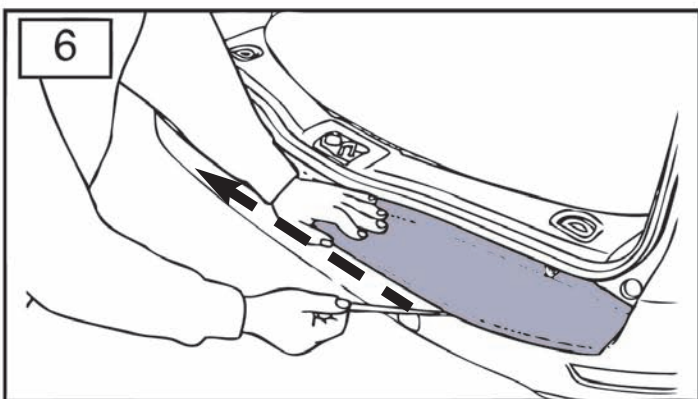
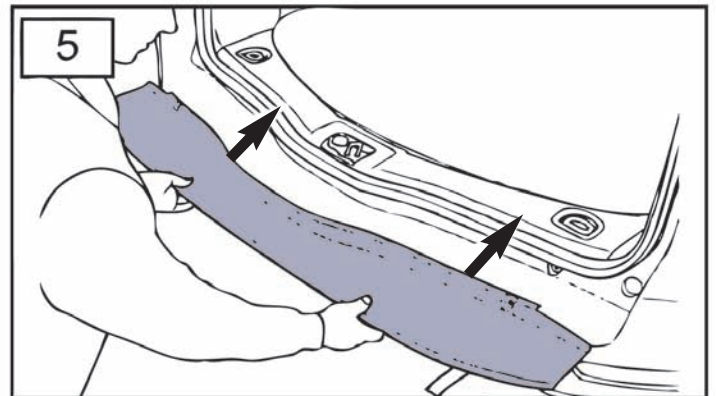
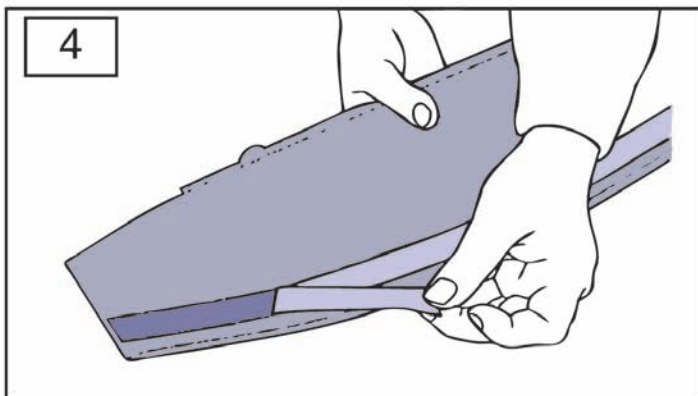
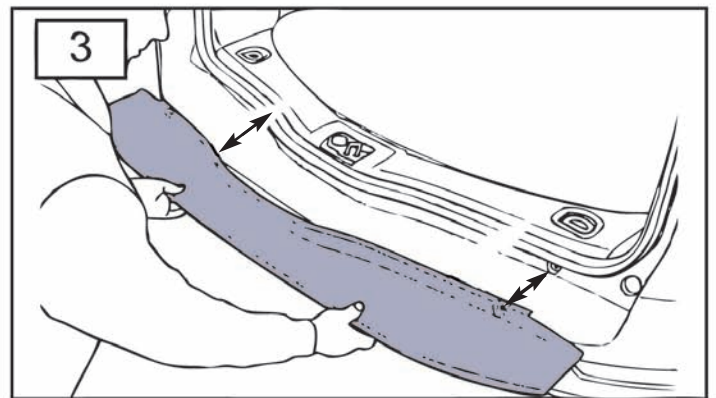
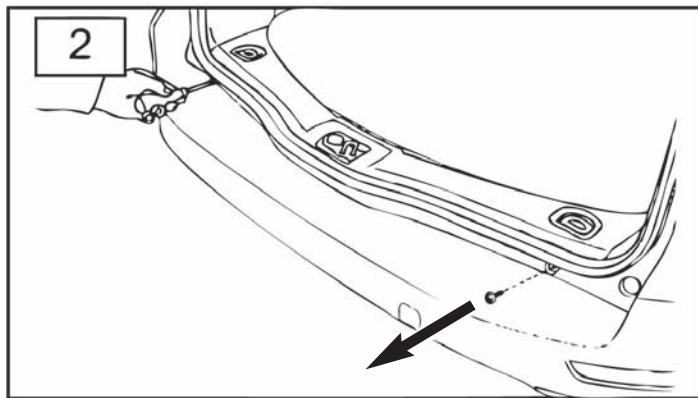
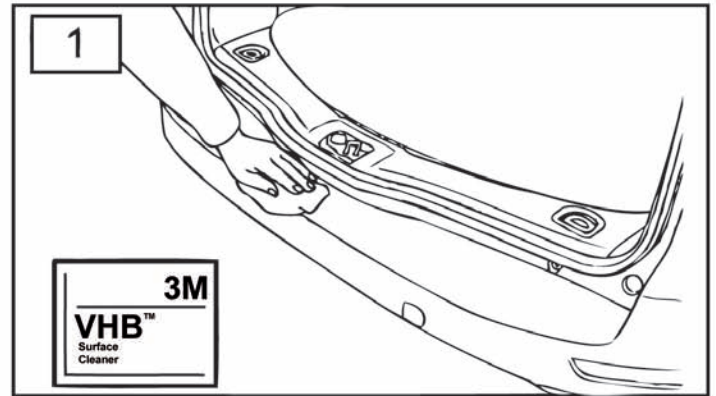
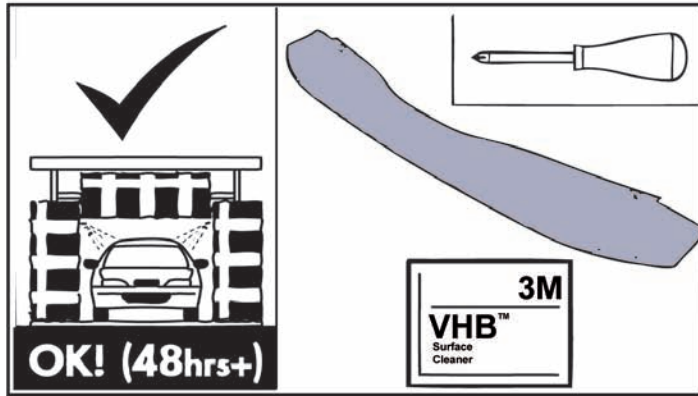

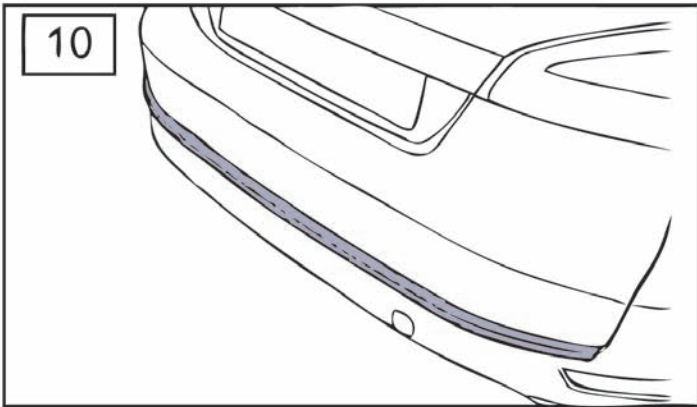
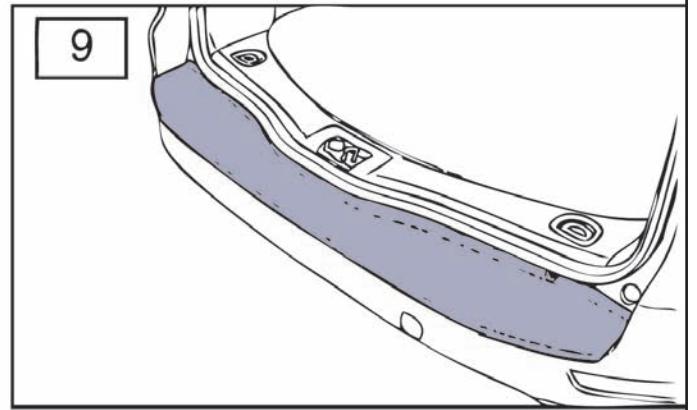
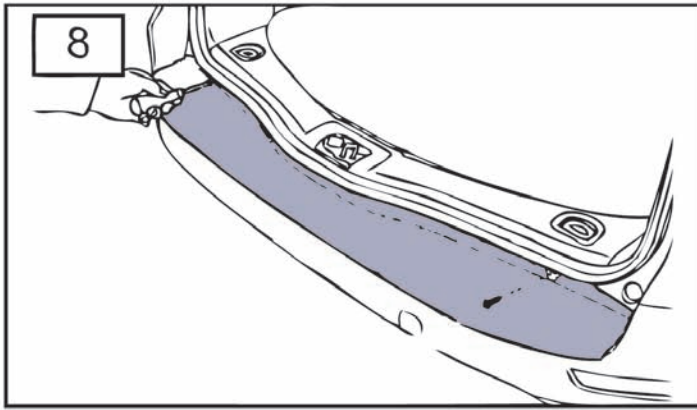

Verwenden Sie nur Wasser mit Seife oder Autoshampoo für die Reinigung Ihres Heckkantenschutz „PROTEXOR“. Spülen Sie mit klarem Wasser ab und trocknen den Rest ab.

Use only water with a proprietary soap or car shampoo for cleaning your REAR PROTECT OR. Rinse off with clean water and dry as per remainder of the bodywork.

ClimAir[®]
Car Comfort

PLAVA Kunststoffe GmbH

Am Spitzacker 22 - 61184 Karben

Telefon: +49(0)6039 - 9 16 3-0

Fax: +49(0)6039 - 21 85

info@climair.de - www.climair.de

PROTEXOR - HECKKANTENSCHUTZ
 PROTEXOR - REAR PROTECTOR
 Einbauanleitung - Fitting instructions

ClimAir[®]
car comfort

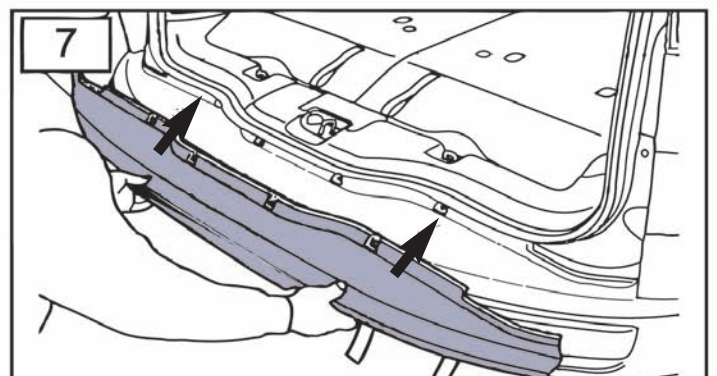
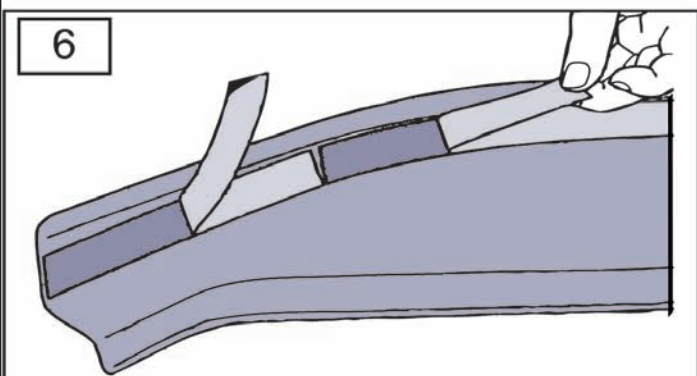
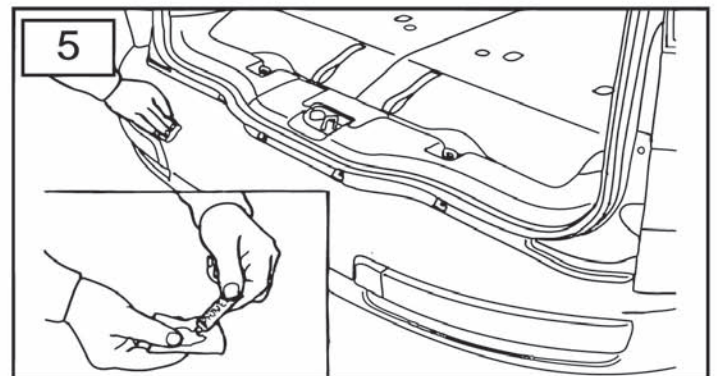
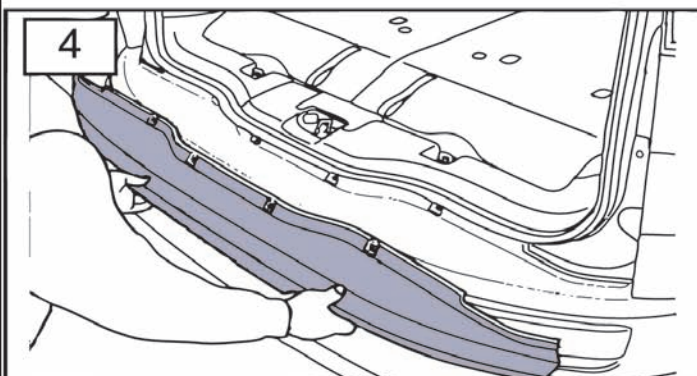
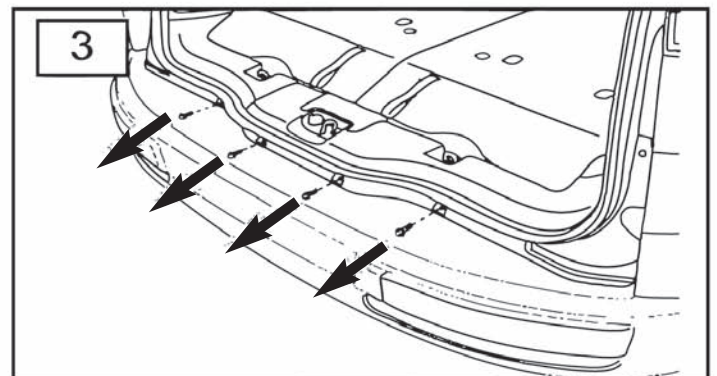
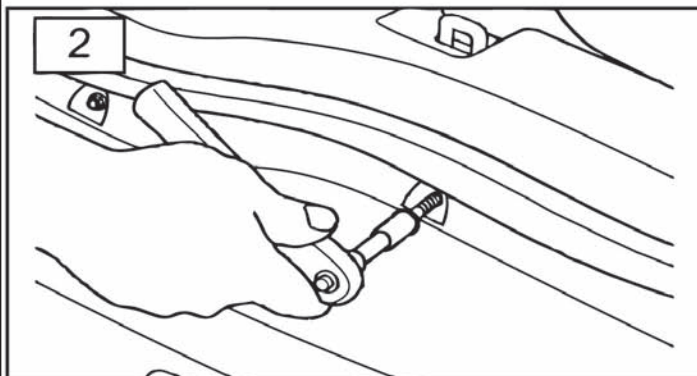
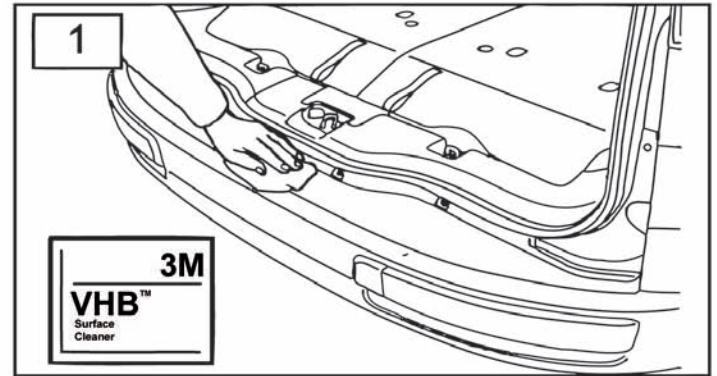
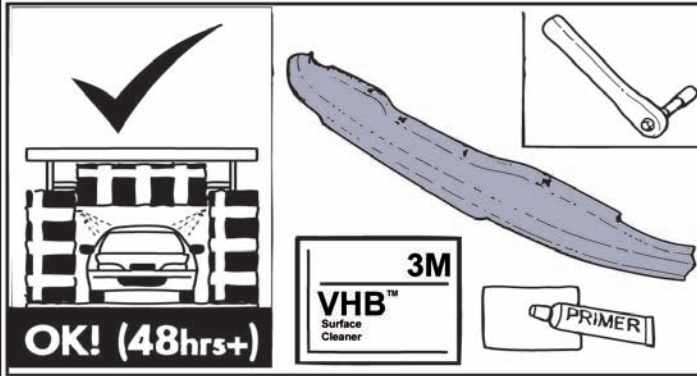

WaCo 09/2010 0779511

Verwenden Sie nur Wasser mit Seife oder Autoshampoo für die Reinigung Ihres Heckkantenschutz „PROTEXOR“. Spülen Sie mit klarem Wasser ab und trocknen den Rest ab.

Use only water with a proprietary soap or car shampoo for cleaning your REAR PROTECTOR. Rinse off with clean water and dry as per remainder of the bodywork.

ClimAir[®]
car comfort

PLAVA Kunststoffe GmbH

Am Spitzacker 22 - 61184 Karben

Telefon: +49(0)6039 - 9 16 3-0

Fax: +49(0)6039 - 21 85

info@climair.de - www.climair.de

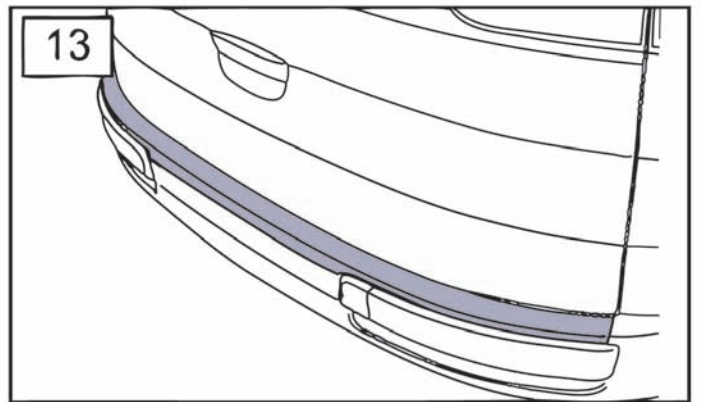
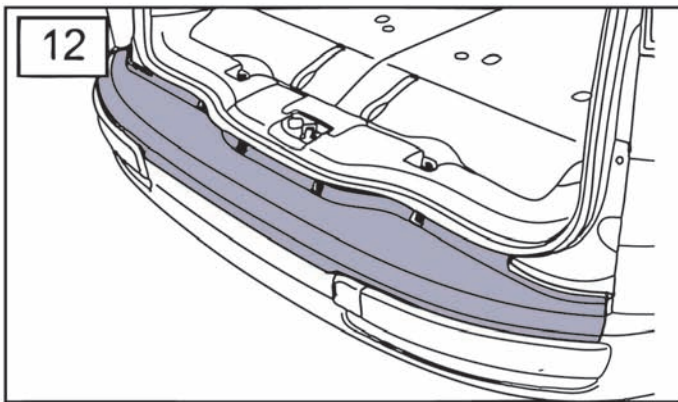
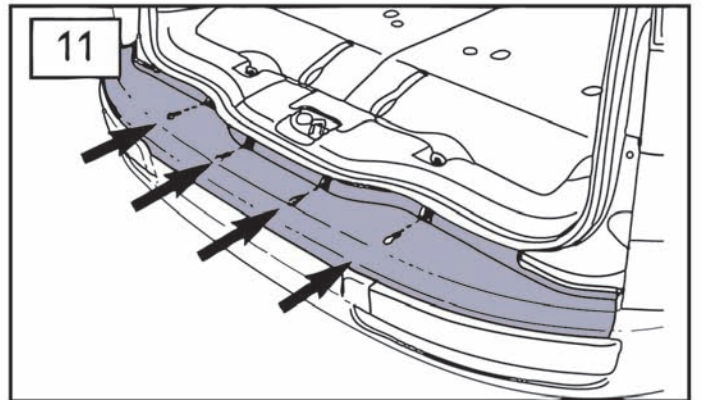
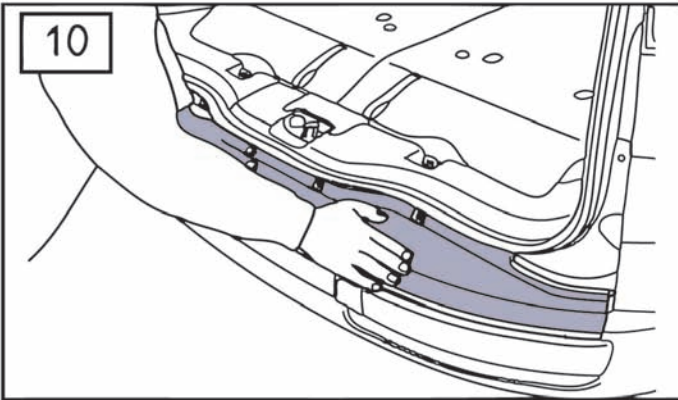
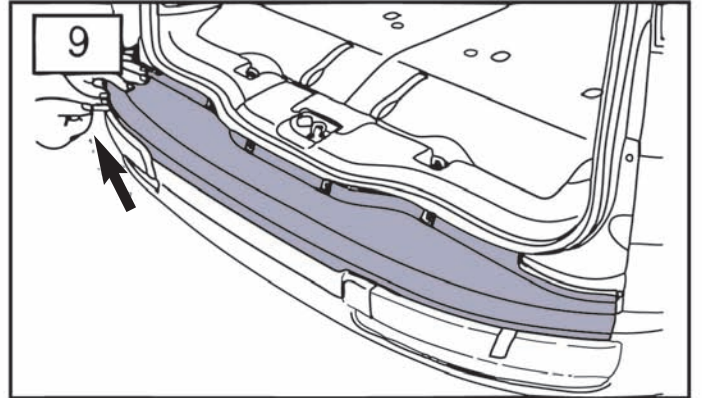
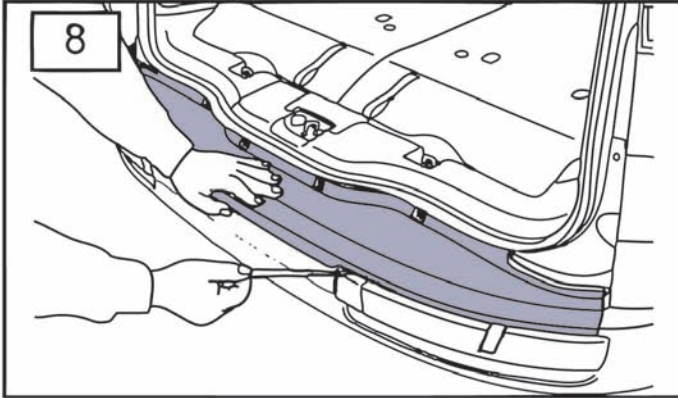

Verwenden Sie nur Wasser mit Seife oder Autoschampoo für die Reinigung Ihres Heckantenschutz „PROTEXOR“. Spülen Sie mit klarem Wasser ab und trocknen den Rest ab.

Use only water with a proprietary soap or car shampoo for cleaning your REAR PROTECT OR. Rinse off with clean water and dry as per remainder of the bodywork.

ClimAir[®]
Car Comfort

PLAVA Kunststoffe GmbH

Am Spitzacker 22 - 61184 Karben

Telefon: +49(0)6039 - 9 16 3-0

Fax: +49(0)6039 - 21 85

info@climair.de - www.climair.de